

Custom-Cut Sauna Kit

installation instructions

Please immediately check for any hidden damage that may have occurred in shipping. If any damage is found you must notify the delivering carrier within seven days.

These instructions were written for contractors and do-it-yourselfers who are constructing their own saunas. Much of the installation is performed with basic construction practices. However, these tips should help make the process easier and help to ensure your sauna is professionally installed for optimum enjoyment.

A. Materials that are NOT furnished include: framing, insulation and exterior finish. (unless specified)

B. All electrical work should be completed by a licensed electrician.

C. Study all the instructions prior to installation.

NOTE: Each lumber bundle is marked as to the order of installation. Minor trimming may be needed to fit job conditions.



Your sauna can be placed on concrete, tile, linoleum, or any surface that does not absorb water. Do not install the sauna on carpeting.

TOOLS REQUIRED

- Hammer and pin nailer
- Handsaw and mitre box (for molding installation)
- Drill or cordless screwdriver
- Tape measure
- Square
- Level
- 3/8" wood bit (if sauna room has an L-bench)
- Note: Torx bit is provided

HINT: We recommend the use of a pneumatic pin nailer for installing the tongue and groove (T&G) boards. This will save more than 50% of labor time and will allow for easier blind nailing. Use 1-1/4" to 1-1/2" galvanized pin nails.

Accessories

*Styles vary based on Interior Design choice.

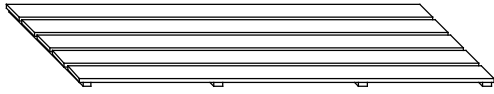

Duckboard

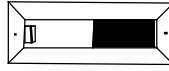

Vent Valve

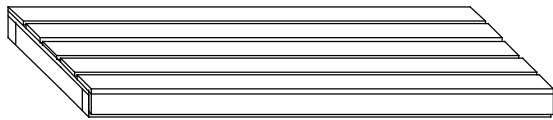

Bench

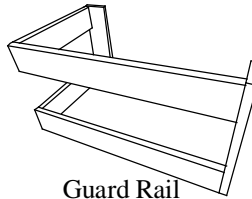

Guard Rail

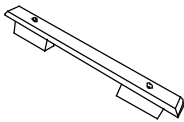

Door Handle



Vent Grill

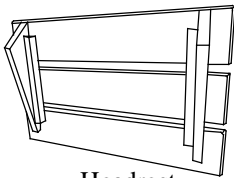

Headrest

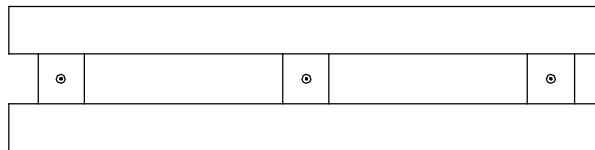

Backrest

Trim Profiles



Cove Molding

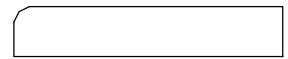

Window/Door Casing

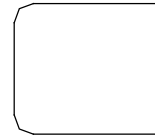

Inside Corner Molding

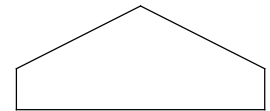

Inside angle corner molding
(on rooms w/more than 4 walls)

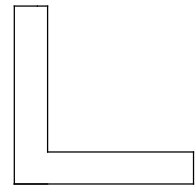

90° corner mold
(when required)

Hardware Package



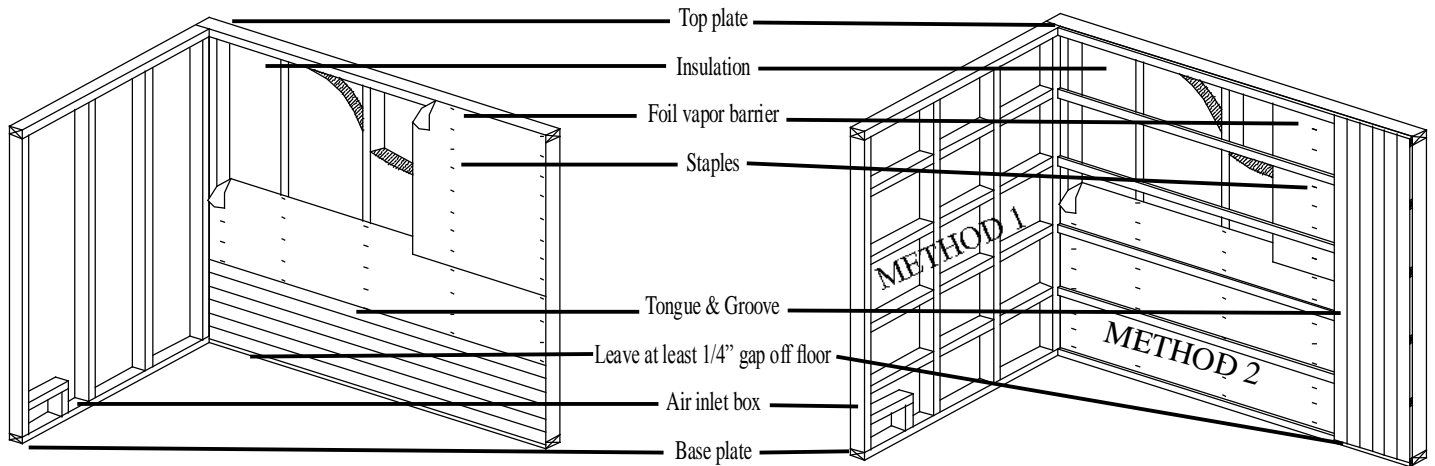

Figure A
Framing for HORIZONTAL tongue & groove application

Figure B
Framing for VERTICAL tongue & groove application

FRAMING CONSIDERATIONS (steps 1-8)

1A. Framing for Horizontal T&G Application (figure A)

The entire sauna should have 2x4 framing on all four sides and the ceiling. If a portion of the sauna is solid wall construction (brick, block, etc.) those walls should be framed with vertical 2x2 firing strips or standard 2x4 framing. All framing is standard 16" on center.

1B. Framing for Vertical T&G Application (figure B)

If you plan to install your T&G vertically, you have two framing options. **Method 1:** Install 2x2 or 2x4 nailers between the studs (figure B method 1). For standard 7' high saunas evenly space and fasten 4 levels of nailers between the top plate and base plate of your walls.

Method 2: For standard 7' high saunas evenly space and fasten six 1x2 furring strips across the studs (figure B method 2).

2. Baseplate (figure C)

We recommend the baseplate be constructed of treated 2x4s for added protection against moisture on the floor. All other framing can be any suitable framing material such as SPF 2x4s. The floor should be a waterproof surface such as tile, linoleum or concrete.

3. Ceiling Framing

The ceiling height should be framed at 7' or less (minimum of 75") off the floor. If the ceiling is currently over 7' it should be dropped for proper sauna performance (figure D). Generally 2x4 ceiling framing is adequate but in cases of a span of 8' or over consider using 2x6 lumber.

4. Corner Studs

Be sure you have a stud in each corner of the room to allow fastening of the ends of the T&G boards (figure E).

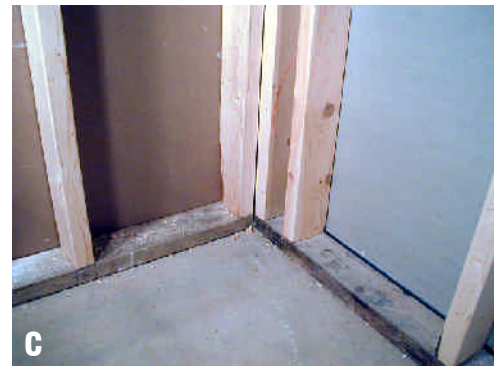



5. Framing the Doorway

Make sure to frame your doorway perfectly plumb and square. Frame the left and right sides with a double 2x4 for added strength (figure F). For a standard wood door create a rough opening (R.O.) 2" wider and 2" taller than the door size ordered. A standard wood door is 24" x 80" and the R.O. should be framed to 26" x 82". For a standard all-glass door, frame your R.O. 3-1/2" wider and 2" taller than the door size ordered. A standard all glass door is 24" x 80" and the R.O. should be framed to 27-1/2" x 82". **See specifications supplied with any custom door.**

NOTE: If you have a handicap (ADA) door, leave the baseplate clear for wheelchair access.

NOTE: If using a standard 80" door, it is typical to have no threshold. If using a 72" door, a single (1-1/2") or double (3") threshold may be desired.

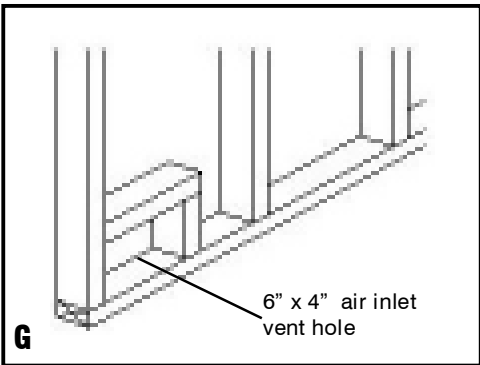

6. Framing for Air Inlet

Every sauna should have two vents; an air inlet and air outlet. The air inlet should be located just below the heater at floor level. Using 2x4s, create a box with inside dimensions of 6" x 4". It is easiest to incorporate a wall stud for one of the sides of your box and the base plate to complete the bottom of your rectangle (figure G).

7. Framing for Air Outlet

The outlet vent should be located as far from the inlet as possible, diagonally across the room. Frame the opening the same size as the inlet (6" x 4") with the top of the opening 23" off the floor in standard situations. It is not recommended to install the outlet any higher than 30" to ensure minimal loss of heat from the sauna. Again, use an existing stud for one side of the vent. Additional 2x4s will need to be cut to form the other 3 sides of the vent.

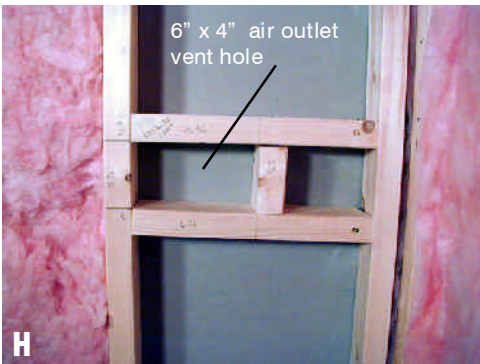

8. Framing for Heater Mounting Bracket

Determine the location of the heater in the sauna as recommended by your sauna representative or as described by your heater installation instructions and template supplied with the heater. Add two 2x4 supports between the studs for the heater brackets (figure I).

NOTE: The metal heater hanging brackets are installed **after** the T&G installation. The height and location of the supports is determined by the mounting instructions supplied with the heater. The 2x4 supports are not needed when using the optional floor stand or commercial floor standing heaters.

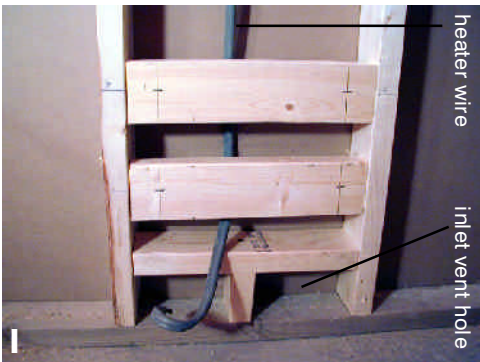

9. Electrical Rough-In

Once the sauna is fully framed, and before the insulation is installed, the electrical rough-in should be done by a licensed electrician.

Warning: Follow wiring instructions provided with the heater. Always use proper wire size and type as specified in your heater instructions provided in your heater box.

Control: If using an external control, have your electrician run wire from your breaker panel to the point on the wall where your control will be mounted; leave a service loop and then continue to the heater.

Heater: Your wires will enter your sauna heater from below (figure I). Be sure to allow enough extra wire (typically 18") to make final hook-up easier.

Light: The light can be mounted on a wall of your choice. Most common is off to one side of the door. Have wire run wire accordingly.

10. Insulation - Always refer to your local building codes.

Using R11 or better unfaced fiberglass batts, insulate the interior walls of your sauna by tucking it between the studs. **NOTE:** Un-backed batts are best to prevent a double vapor barrier which could trap moisture. If you only have backed insulation keep the paper/foil side to the interior of the room. For the ceiling use either a single layer of 6" fiberglass (figure K) or you may wish to use a double layer of 3-1/2" fiberglass. To do this, hang the first layer perpendicular to the ceiling joists and then pound nails into the bottoms of the joists and hang the second layer on the nails between the joists.



11. Vapor Barrier

Your custom-cut sauna kit comes with a roll of foil vapor barrier. The foil has a dual purpose acting both as a vapor barrier and heat reflectant. Apply the vapor barrier to the inside framing using staples being sure to cover all walls and the ceiling. Roll it out horizontally covering the bottom of the walls first and working your way to the top overlapping about 5" (figure L). If desired, you can tape the joints using foil tape (not provided).



Tongue & Groove Installation

Custom cut packages include tongue and groove (T&G) lumber already cut to specified length. Each package of boards is labeled for location and the sequence in which it is installed... (1. Ceiling, 2. Back Wall, 3. Side Walls, 4. Front Wall). Also, the benches are pre-built and the door is pre-hung. Refer to your custom cut worksheet as a guide for sequence. **Warning:** We recommend using only galvanized or stainless steel fasteners to help prevent corrosion. Your custom-cut kit includes some galvanized nails for trim, stainless steel screws, and coated screws.



12. Ceiling T&G

Install the ceiling boards before the walls so the ceiling boards are supported at their edges. Your ceiling boards will be installed perpendicular to your ceiling joists unless you have special nailers installed. Face-nail through the board on each end (figure M). These nail heads will later be covered by trim. Then blind-nail into the joists using the proper method described below.

Note: Measure each end after installing every 3-5 boards to prevent "fanning".

There are 2 methods of fastening your T&G boards: one is using a pneumatic pin nailer (preferred) and the other is using a hammer and finishing nails. The use of a pin nailer will **dramatically** speed up this procedure. Use 1-1/4" to 1-1/2" pin nails.

(Pin nailer method (figure N)) Start application making sure the tongue of your first board is up against the wall. Face nail on both ends and blind nail through the groove at each joist.

(Hammer & nail method (figure O)) Start application making sure the groove side of your first board is up against the wall. Using 1-1/4 to 1-1/2" galvanized nails, face nail on both ends and blind nail through the tongue at each joist. Countersink your nails with a nailset.



13. Continue with the other ceiling boards, face-nailing through the ends and blind-nailing at each ceiling joist. Your last ceiling board most likely will need to be ripped in order for it to fit.

Horizontal Wall T&G

In general cases the interior T&G boards are provided at proper length so no cutting is necessary. This length is slightly shorter than the wall to prevent binding and tearing of the vapor barrier. In some saunas the front/door wall T&G boards are sent longer than needed so they can be cut to fit once the door framing is complete; depending upon information provided at the time of order.

NOTE: It is recommended to install the T&G with tongue side up. This will help prevent any moisture from collecting in the groove.

OPTION: Your T&G boards may vary in shade particularly with cedar or redwood. To make a nice transition, lay out all your boards for a given wall in a pattern from light to dark (figure P). In general cases fasten your lighter boards towards the top of the wall and darker ones towards the bottom, but personal preference is the rule.

***If you are doing a Vertical T&G installation go to step 17.**

15a Horizontal Wall T&G Installation “Top Down” Method (when using a pin nailer)

Start at the top of the back wall and position your first piece of T&G along the wall with the tongue towards the ceiling. Making sure it is level (figure Q), nail it into place using the same method shown for the ceiling T&G; face nail along the ends and blind nail on each of the studs. Any gaps between your ceiling and your top wall board will later be covered by trim. **Go to step 16.**

15b Horizontal Wall T&G Installation “Bottom Up” Method (when using a hammer and galvanized nails)

In order to keep your T&G application level and dry it is necessary to first put a starter board at the bottom of each wall. Find the highest point on the sauna floor to use as a reference. Assuming your ceiling is level, measure down from it in each corner and mark a common distance (1/4” minimum) short of your reference point in each corner.

Hint: Keeping your boards off the floor prevents them from soaking up any moisture that may accumulate there.

NOTE: Do not take measurements up from the floor since you want the top board of each wall to be level with your ceiling. If there is a significant slope to the floor (1 inch from one side to the other) rip your bottom board at a taper to allow for this slope. It is important to install your bottom starter row perfectly level along all walls making sure the groove ends are matched up in the corners (figure R). This first row acts as a guide for the rest of the interior T&G installation.

16. Continue fastening your T&G along the wall (figure S) till you reach your last board either at the top or bottom. You may need to rip your last board to fit making sure your bottom board is at least 1/4” off the floor. Finish the rest of the interior in the order of back wall, side walls, and lastly the front (door) wall.

HINT: When installing the short pieces on each side of the door or windows use a full length board as a guide to keep the pieces on both sides aligned and level; then nail them into place (figure T).

***Continue with step 19.**



17. Vertical Wall T&G

Your first board on each wall should be fastened with the tongue side towards the corner if you are using a pin nailer and the groove side towards the corner if using hammer and nails (as was done for the ceiling). It is easiest to work from left to right if you are right handed and vice versa. Always butt your vertical boards against the ceiling to keep them about 1/4" off the floor. Face nail your boards at the top and blind nail them at each nailer as was done for the ceiling (figure U). Your interior trim will later cover the nail heads at the top.

HINT: When installing short pieces above or below a window, use a full length board as a guide to keep the short pieces aligned and level (similar to figure T but with a vertical orientation).

18. Keeping your boards vertical, continue blind nailing them into place along the walls until all your walls are covered. Your last board on each wall may need to get ripped in order to fit into the corner.

19. Vent Valve

The vent valve is to be placed over the outlet vent hole in the interior of the sauna. Slide the valve door open and place the opening directly over the 6-” x 4” cutout. Making sure it is level, fasten it with two 1-1/2” screws (figure V).

20. Vent Grill

From the outside of the sauna, center the wood grill over the exterior of the 6” x 4” cutout, with the louvers facing down. Making sure it is level, fasten with four 1-1/2” screws (figure W). If your back wall is hidden, the grill is not needed.

NOTE: In most cases the inlet vent under the heater will be covered by the heater so no grill or trim is needed on the inside; the outside grill is provided. If you must place your inlet vent in a location other than below the heater you can purchase another vent grill from your supplier.

21. Bench Supports

In most cases your lower benches have longer supports to allow them to be slid in and out for easy cleaning. Measuring from the floor, mark a line at 12” and 30” on the walls where your bench supports will be fastened. These measurements will be the top edge of the 2x4 supports. Each support is long enough to span at least 2 wall studs. This will allow for at least two 3-inch screws, per support, to be anchored into wall studs for necessary strength. Making sure they are level, position them on the wall and use 3” screws to secure the supports to the walls (figure X).

NOTE: By using the above measurements your final bench heights will be approximately 18” for the lower and 36” for the upper benches. If you have a ceiling height other than 7’ these bench heights can be adjusted for head clearance or better heat.

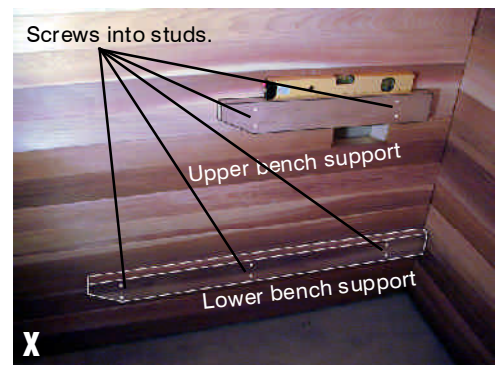
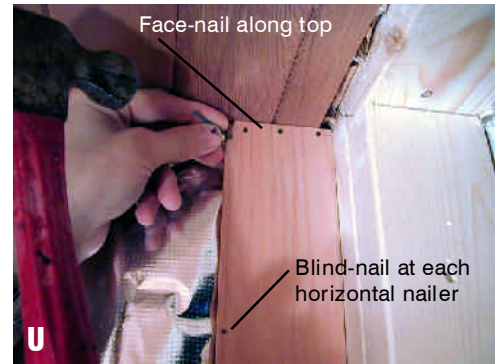

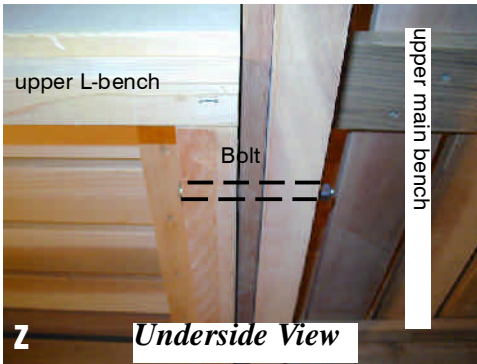

NOTE (for saunas with an L-shaped top bench): On saunas having an L-shaped top bench, you will have an additional upper bench support. Fasten them to the walls so the tops are 30" off the floor. Two 3/8" holes have been drilled through the frame of the upper L-bench. With the top of the upper benches aligned, use a 3/8" drill bit and drill through the 2 provided holes and through the face of the main upper bench. Bolt the two benches together using the 5-1/2" carriage bolts provided (figure Z).

22. Cove Molding

The cove molding (3/4" x 1") will be provided longer than needed to allow trimming to exact size to insure a tight fit. Measure each wall to determine cut length. A simple butt-end cut is the easiest. Cut molding straight, then butt the pieces together (figure AA). If you prefer a mitre joint, the molding is long enough to accommodate that type of cut as well. Using #4 finishing nails, nail the cove molding to the walls.



23. Corner Molding

The corner molding (3/4" x 3/4") is used to trim the corners of the room where the walls meet (figure BB). On corners without benches, cut molding full length and install with finishing nails. On corners with benches, cut the molding in two pieces; one from the bench surface up to the cove molding and the other from the bottom of the bench support down to the bottom of the wall T&G.



24. Backrest (not included with all models)

Position your backrest in the mid-back/shoulder blade area, whatever feels most comfortable. A typical height is 20" from top of bench to top of backrest. Making sure it is level, hold the backrest at your preferred height, fasten it to the wall through the predrilled holes, using 2" screws (figure CC). Wood plugs are provided to cover the exposed screw heads.

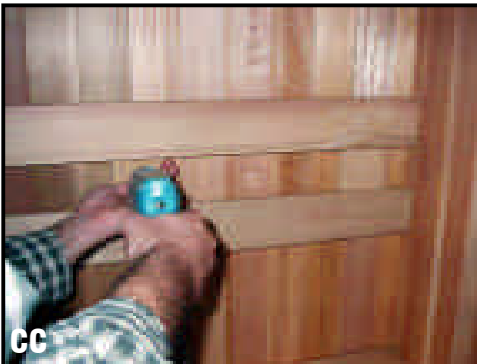

25. Interior Light

The light should be wired by a licensed electrician according to local codes. Mount the light in the location where your wire comes through the wall (figure DD). If you plan to use a corner lampshade, the light will need to be installed tight into a corner approximately 4" down from the cove molding.

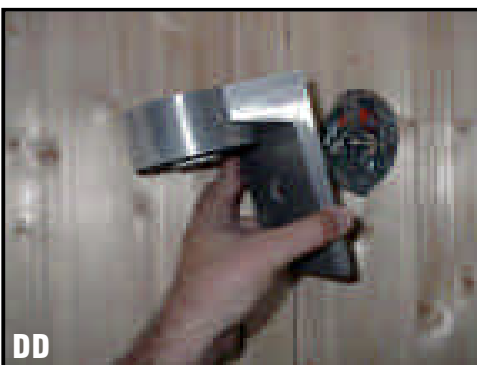

26. Sauna Heater

The heater should be wired by a licensed electrician according to the specifications provided with the heater. The mounting instructions are provided with the heater.

27. Rock Placement (Very Important)

Please refer to the heater instructions for full details.

28. Heater Guard

Place the heater guard around the heater as described in your heater instructions; spacing may vary according to heater kilowatt. Making sure it is level, fasten it to the wall with 2" screws (figure FF).

NOTE: The front rails of the 2-sided heater guard can be cut to desired length before assembly.

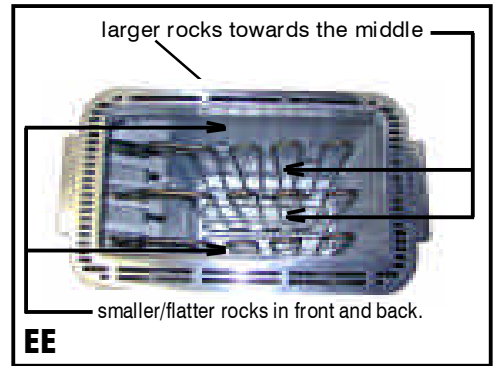

29. Door Installation

The door is pre-hung with a jamb. Please note that sauna doors must always swing out.

30. Place the door into the framed opening and fasten the hinge side to the 2x4 frame using provided 3" screws. Mount so the door jamb is flush with the surface of the exterior wall material. Be sure the door is level and plumb. If it is not, use shims between the opposite side jamb and frame. Check for uniform spacing at the top of the door and jamb then continue to fasten around the frame (figure GG).

31. After the door is secured in place, install the jamb extensions if provided (figure HH). The jamb extensions should be flush with the surface of the T&G on the interior sauna walls. The tapered edge of the jamb extension butts up against the existing door jamb. The easiest way is to nail the extension to the side of the framed opening (an alternative method is to attach the extensions to the door frame itself). After jamb extensions are secured, install the interior door casing provided. The casing should cover most of the jamb extensions (leave about 1/8" of jamb showing for a reveal). Nail to the jamb and to the walls inside the sauna room. The exterior of the door is typically trimmed to match the molding in the adjacent room. If exterior T&G was purchased, extra trim is provided.



32. Door Handle

A pair of door handles is provided with each door. Using the screws provided, install the door handles with the center of the handle approximately 36" off the floor (or whatever height is most comfortable). After the handles are fastened, install the provided wood plugs to fill the holes.

